

SpiN tAble

SpiN tAble

all around a fexible office

ICF

Spin Table è il nuovo sistema modulare di tavoli progettato per l'ufficio moderno.

Scrivanie singole e spazi per gruppi di lavoro, tavoli riunione e tavoli da conferenza: Spin Table si mette al servizio dell'ufficio e cambia caratteristiche in funzione delle specifiche esigenze degli ambienti. Perché, in questo caso, la flessibilità e la versatilità rappresentano qualcosa di molto concreto: semplicemente mettersi a disposizione del pubblico, per realizzare la soluzione ottimale.

Spin Table is a new modular table system designed for modern offices.

Individual desks, workstations areas, meeting and conference tables: Spin Table is specifically designed for offices and conference rooms. And modifies its features to suit any environment. Its flexibility and versatility enable the end user to quickly and easily create the ideal solution in a fluid environment.



single desk



Spin Table prevede una vasta gamma di accessori: canalina passacavi, portalamпада, sportello in alluminio e vertebra.

Spin Table offers a wide range of accessories: cable trays, lamp holder, aluminium flip door and cable spine.

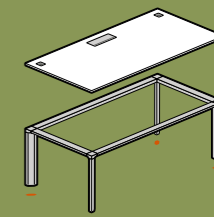

Il modulo base dello Spin Table è stato progettato con la massima essenzialità: è una cornice sottopiano in alluminio abbinata al piano di lavoro. E' un prodotto che garantisce massima flessibilità all'ambiente di lavoro e la possibilità di riconvertire in qualsiasi momento la situazione iniziale.

The base module of the Spin Table was designed to be as simple as possible: a worktop of chosen finish mounted on an aluminium frame. The table is therefore a product that guarantees maximum flexibility in the workplace and the possibility of re-adapt its configuration at any time.



double desk

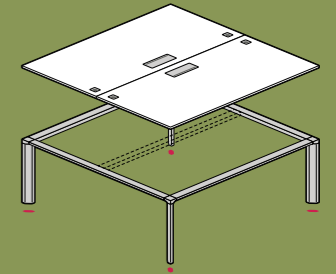

Creare un ufficio operativo funzionale e moderno rappresenta uno degli obiettivi progettuali di Spin Table. Il piano di lavoro è una delle novità significative, e non solo per la vasta gamma di colori e finiture disponibili, che consentono di dare all'ufficio un'immagine vivace e colorata, fresca e tecnica. E' infatti stato pensato per poter aggregare con la massima semplicità due piani: si trasforma così da scrivania singola a doppia, utilizzando al meglio lo spazio.



To create a modern and functional operative office is one of the Spin Table's aims. The worktop is one of its most significant innovations, not only for range of available finishes and colours, creating a lively, fresh and high-tech appearance. It has also been conceived with the ability to join together two tops very easily, in such a way that it turns from a single desk to a double desk, and beyond, for better space organization and economy.

Il piano in cristallo satinato e retroverniciato è disponibile in cinque colori; la fascia tecnica è in colore abbinato alla struttura del tavolo.

The frosted and underpainted glass tops are available in five colours and technical band is in solid laminate matching the frame colour.



Spin Table è disponibile in varie tipologie:

1. piano unico non elettrificato
2. piano unico con sportello e tappi passacavi utilizzabili per fissare vari accessori
3. piano caratterizzato da una "fascia tecnica" che organizza le esigenze del wire-management e da una parte estetica in cristallo retroverniciato acidato.

Spin Table is available in different types:

1. single top without wire management
2. single top with flip door and grommets which can be used to fix the different accessories
3. top with a "technical band" for the location of wire management accessories, and a worktop made of underpainted acidated glass



Le scrivanie sono disponibili con piano in cristallo retroverniciato acidato, in essenza o in laminato; con la struttura in alluminio estruso verniciato in bianco, in grigio scuro o lucidata; con i giunti in alluminio pressofusi.

The desks have underpainted acidated glass tops, wood veneer tops or laminate tops; the frame is in extruded aluminium, painted in white, dark grey or polished. The connectors are in die-cast aluminium.



Scrivania doppia con struttura verniciata bianca e piani in cristallo retroverniciato arancione.

Double desk with white painted frame and underpainted glass tops.

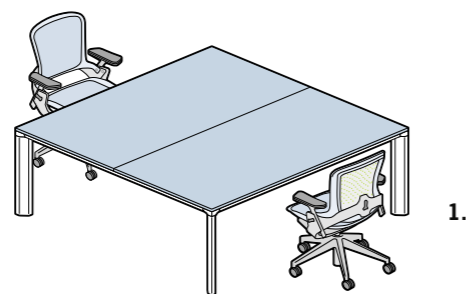

1.

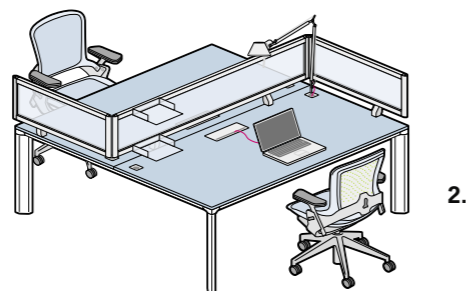

2.

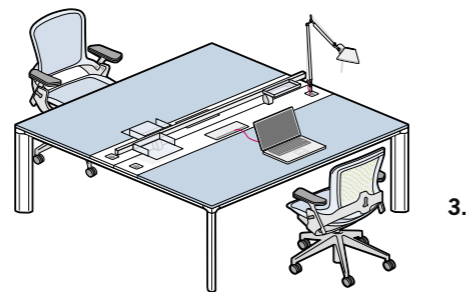

3.

Spin Table è disponibile in varie tipologie:

- 1. piano unico non elettrificato
- 2. piano unico con sportello e tappi passacavi utilizzabili per fissare vari accessori
- 3. piano caratterizzato da una "fascia tecnica" che organizza le esigenze del wire-management e da una parte estetica in cristallo retroverniciato acidato.

Spin Table is available in different types:

- 1. single top without wire management
- 2. single top with flip door and grommets which can be used to fix the different accessories
- 3. top with a "technical band" for the location of wire management accessories, and a worktop made of underpainted acidated glass



team table

Spin Table is a product created for modern offices, where needs can change very quickly. It can be used as a single desk or very easily joined together with other modules, simply turning and sharing a leg. Spin offers the workplace the maximum flexibility by enabling the user to re-adapt its configuration at any time. The assembly is very easy too: the legs can be quickly fixed to the frame without tools.

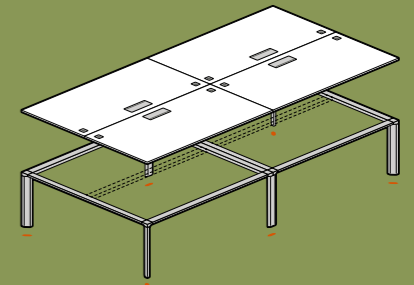

Spin Table è un prodotto destinato all'ufficio moderno, dove le esigenze e le necessità variano piuttosto rapidamente. Può essere utilizzato singolarmente o collegato ad altri moduli semplicemente girando e condividendo la gamba. È un prodotto che garantisce massima flessibilità all'ambiente di lavoro e la possibilità di riconvertire in qualsiasi momento la situazione iniziale. Anche il montaggio non è un problema: le gambe possono essere agganciate alla cornice velocemente senza l'uso di attrezzi.



accessories

Progettare oggetti capaci di svolgere una funzione nel migliore dei modi: la qualità del lavoro si ottiene anche mediante la qualità degli ambienti di lavoro.
Spin Table è conforme alla normativa europea uni 527: è prevista la possibilità di regolare l'altezza delle gambe con un'escursione di 12 cm.

Objects designed for excellent functional performances: work quality results from quality work environments too.
Spin Table complies with European regulation UNI 527: it is possible to adjust the leg height with 12 cm extension.

EN

Spin Table is tested to the European Security Directives for workplaces.

Spin Table è conforme alle direttive europee in materia di sicurezza del posto di lavoro.

I componenti principali del sistema Spin sono:

1. connettore in alluminio presso fuso lucidato o verniciato
2. struttura perimetrale in alluminio estruso
3. elementi di elettrificazione: passacavi e raccogliacavi presenti sotto il piano di lavoro
4. regolazione in altezza meccanica o elettrica disponibile a richiesta
5. schermi e pannelli divisorii disponibili in vari materiali

The main components of the Spin system are:

1. connector in die-cast aluminium, painted or polished
2. frame in extruded aluminium, painted or polished
3. wire management: grommets and cable tray under the worktop
4. height adjustment available upon request
5. desk screens and panels available in various materials and finishes

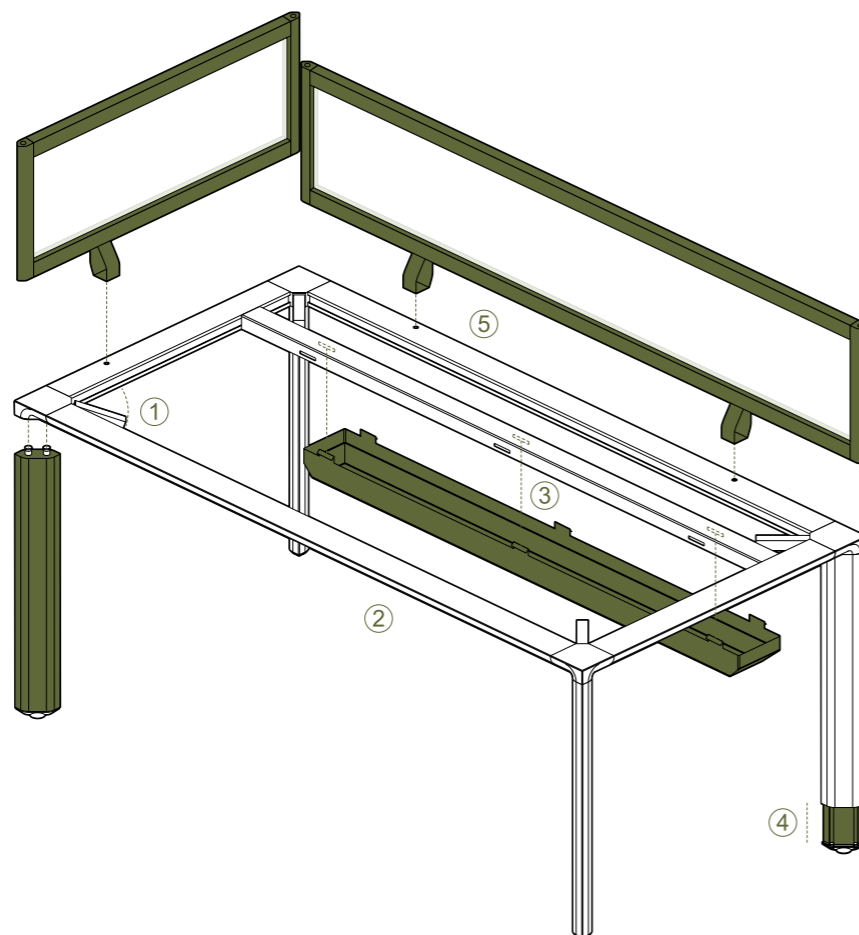

NO TOOLS installation

La facilità di installazione, senza attrezzi e senza l'intervento di personale specializzato, è una delle principali caratteristiche di Spin Table. Poiché è un prodotto destinato all'ufficio moderno, dove le esigenze e le necessità variano piuttosto rapidamente, è possibile montarlo veramente in pochi minuti, variando così l'organizzazione dell'ufficio anche in tempi assolutamente brevi.

One of the main characteristics of the Spin Table is the facility of installation, that can be made without tools and without an installer being called. Being a product created for modern offices, where needs can change very quickly, it can be assembled really very easily, so that the office organisation can be changed on demand.

packaging



release the mechanism



fix the leg



close the mechanism



fix the other legs in the same way



reverse the table



Spin Table arriva nei vostri uffici in un piccolo imballo: con la massima semplicità potrete montarlo e averlo immediatamente a disposizione.

Spin Table is delivered in compact form: it can be installed very easily and it's therefore quickly ready for use.



easy installation

Il meccanismo di fissaggio rapido è disponibile di serie per tutti i tavoli riunione. La struttura in alluminio può essere lucidata o verniciata in vari colori.

The easy lockable mechanism is available as a standard on all the meeting tables. The aluminium frame can be polished or painted in different colours.

single table



release the mechanism



rotate the legs



add the table



close the mechanism



Le gambe, che si agganciano alla cornice velocemente e senza attrezzi, collegano i singoli moduli utilizzando in maniera efficace la struttura in alluminio. E' così possibile, mediante la presenza di un adeguato numero di gambe, aggregare più piani e adeguare l'ufficio alle esigenze particolari.
Il piano dello Spin Table, realizzato nelle diverse versioni, crea con la fascia tecnica in stratificato full color un grande numero di combinazioni.

The legs, which can be quickly hooked to the frame without tools, link the single modules taking an effective advantage of the aluminium frame. This way, and with the proper minimum number of legs, several tops can be joined to make the office suitable for special needs.
The top of the Spin Table, in its various versions with a technical full-colour laminate strip, creates an infinite number of possible combinations.



meeting table

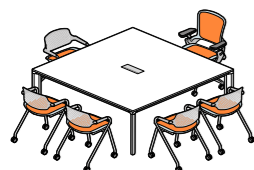

Spin Table è un sistema di piani che può essere utilizzato per comporre diverse soluzioni. E' stato progettato in modo da realizzare, con esiti altamente qualitativi, composizioni di tavoli riunione con forme e misure differenti. Con la massima flessibilità, mantenendo sempre un'immagine pulita e una funzionalità ideale. Perché, in questo caso, la flessibilità e la versatilità rappresentano qualcosa di molto concreto: semplicemente mettersi a disposizione del pubblico, per realizzare la soluzione ottimale.

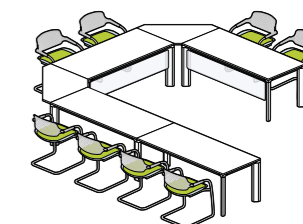

Spin Table is a system of worktops that can be used to combine different solutions. It was designed to create, with very high quality results, compositions of meeting tables with different shapes and sizes. Enabling maximum flexibility, this system always offers a neat and tidy image and the ideal functionality, giving precise solutions to the user's needs.

colours



Il piano dello Spin Table è disponibile in molte finiture e materiali. Viene infatti realizzato nelle versioni in essenza, in laminato e in cristallo retroverniciato in vari colori, creando con la fascia tecnica in stratificato full color un grande numero di combinazioni.
La struttura è disponibile nelle versione lucida o verniciata nei colori: bianco, grigio chiaro e grigio scuro.

Spin Table top is available in many finishes and materials. Wood, laminate and underpainted glass in a wide selection of colours to create an extensive number of combinations with the full colour technical strip.
The frame is available in polished or painted version in: white, light grey and dark grey.

1_ piani/top

1_ laminati/laminate



grigio chiaro
light grey



grigio scuro
dark grey



bianco
white

2_ legni/wood



rovere sbiancato
bleached oakwood



noce nero americano
american black walnut

3_ cristallo/glass



bianco
white



grigio metallizzato
metal grey



arancio
orange



giallo lime
yellow lime



avio
avio

2_ fascia tecnica/wire management

1_ laminato stratificato/full color



bianco
white



grigio scuro
dark grey

1_ single desk

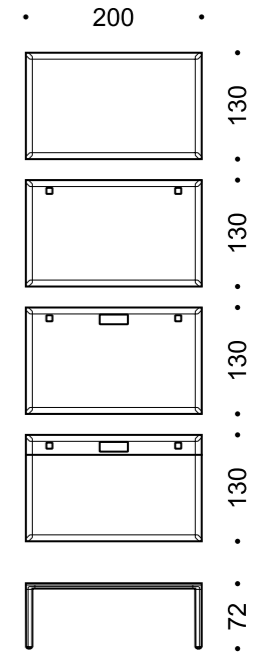
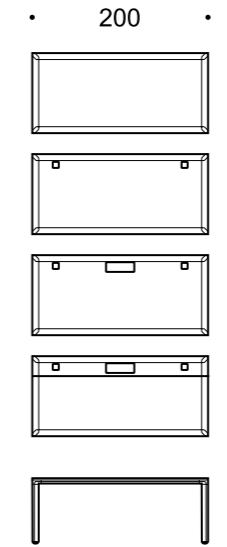
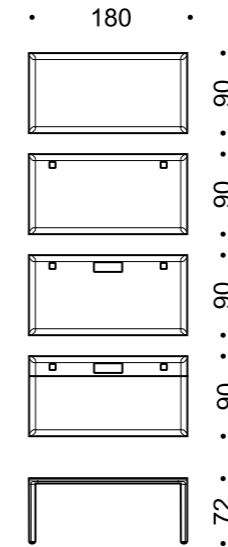
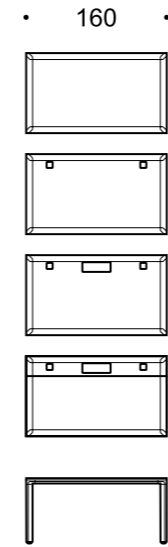

1_ meeting tables

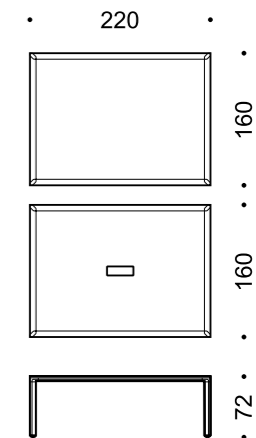
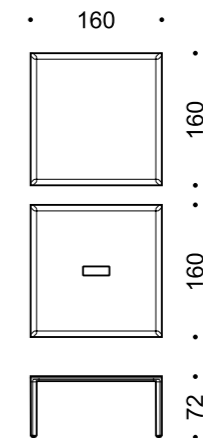
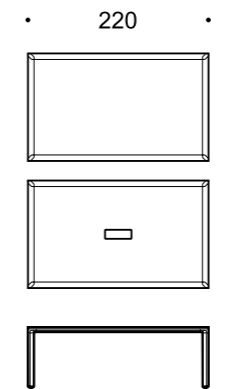
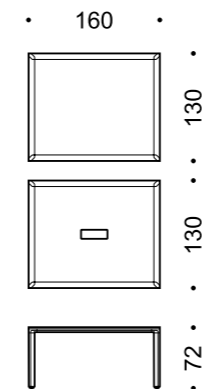
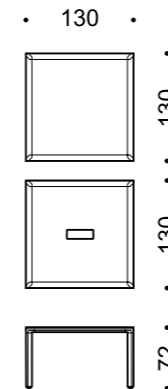

Le dimensioni sono in centimetri.
Sizes are in centimeters.

3_ twin desks

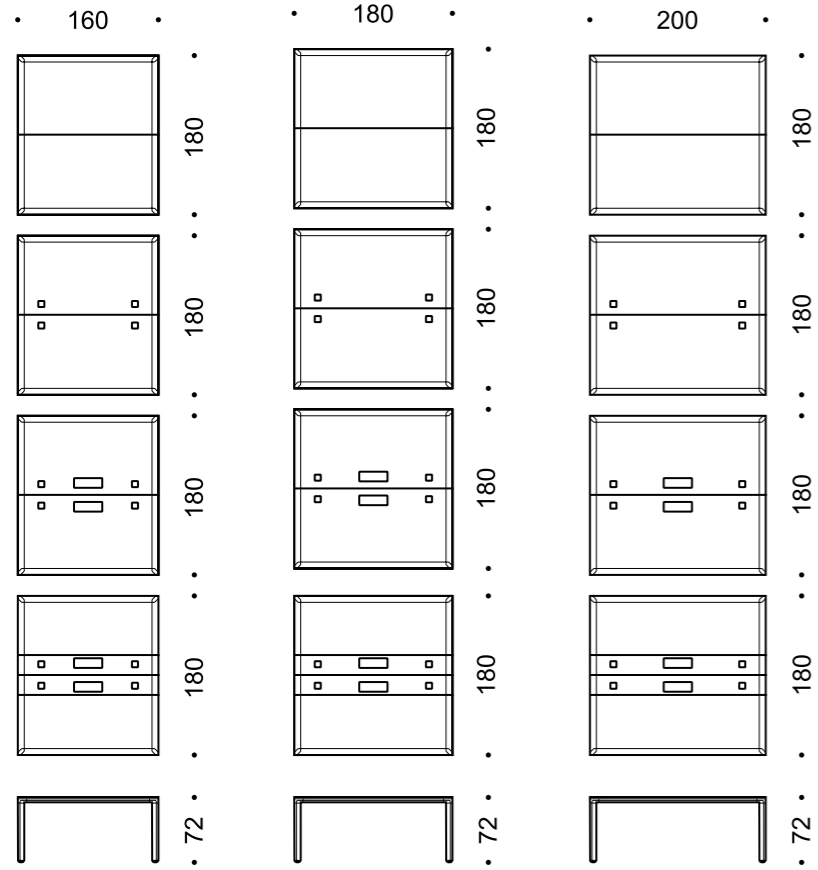

4_ modular meeting tables

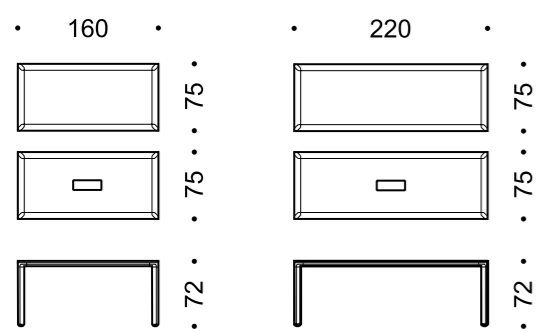

Le dimensioni sono in centimetri.
 Sizes are in centimeters.

ICF spa
via Cassanese, 108
20060 Vignate
tel. +39 02 9508031
fax +39 02 95364012
icf@icf-office.it
icf-office.it

ICF